

# TITAN 8 LED OPL 3000K /E/

IP65 rated LED-based luminaire

## Description

Inexpensive and highly efficient indoor/ outdoor luminaire. Features a wide array of applications, high degree of environmental protection (IP65, IK08), attractive design, easy installation, and luminous efficacy of up to 100 lm/W. Versions with sensor available.

## Installation

Mounted on the ceiling surface indoors or under a canopy.

## Design

Die-cast aluminium housing.

## Optical part

Opal (OPL) or clear polycarbonate diffuser. LED type: SMD.

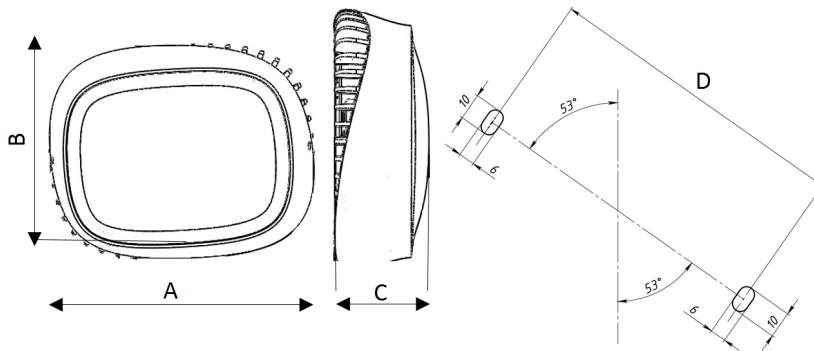
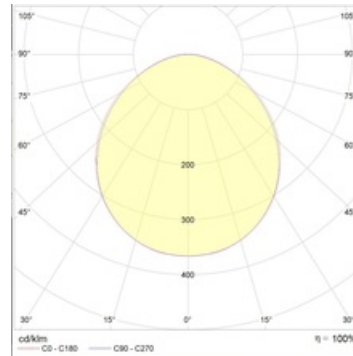

## Dimensional characteristics

A	Length	155 mm
B	Width	130 mm
C	Height	55 mm
D	Length (mounting)	118 mm
	Weight	0.6 kg

## Technical features

1	Article no.	1997026080
2	Light source	LED
3	Luminous flux	750 lm
4	Power compatibility	9 W
5	Energy efficiency	83 lm/W
6	Color rendering index (CRI)	>80
7	Color temperature	3000 K
8	Power factor (cosFI)	> 0,96
9	Alternating/direct current (AC/DC)	No
10	Dimming	-
11	Rated voltage	230 V
12	Electrical shock protection	I
13	Electromagnetic compatibility (EMC)	Yes
14	Climate application	Clm App2
15	Ambient temperature	-40 to +40 C
16	Housing color	Metallic
17	Fire protection class	-
18	Flickering	100%
19	Ingress protection (IP)	IP65
20	Mechanical shock protection	IK08/6,5 J
21	Energy efficiency class	A+
22	Inrush current	-
23	Inrush current impulse time	0 µs
24	Emergency power supply unit	No
25	Beam angle	D120
26	Warranty	60 months
27	Autonomy in emergency mode	-
28	Light flux in emergency mode	-