

RADO 18 BL D45 3000K (with driver)

Recessed LED-based luminaire

Description

Recessed LED downlight, made of aluminum, painted matt paint. Optical part protected by glass. Standard color: WH – white. Standard reflector – 45 degr.

Installation

Installed in ceilings.

Design

The body is made of aluminium. Decorative frame is made from aluminium and painted from matt white. The luminaire have a protective glass or lens. Depending on the type luminaire used (grid, matt difusser, prisma etc.) different versions are available.

Optical part

Lens/reflector

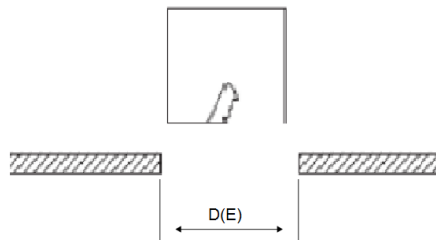
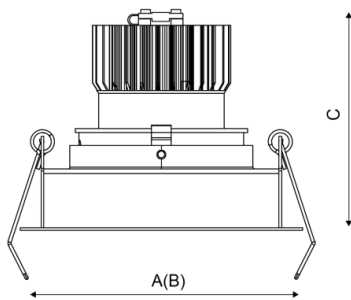
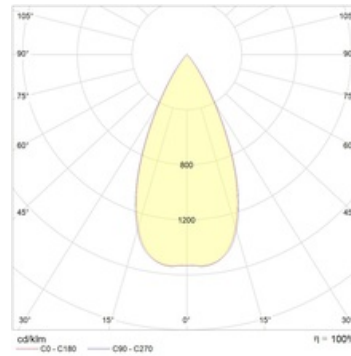

Dimensional characteristics

A	Length	108 mm
B	Width	108 mm
C	Height	120 mm
D	Length (mounting)	96 mm
E	Width (mounting)	96 mm
	Weight	0.7 kg

Technical features

1	Article no.	1278000270
2	Light source	LED
3	Luminous flux	2150 lm
4	Power compatibility	20 W
5	Energy efficiency	108 lm/W
6	Color rendering index (CRI)	>80
7	Color temperature	3000 K
8	Power factor (cosFI)	> 0,80
9	Alternating/direct current (AC/DC)	No
10	Dimming	-
11	Rated voltage	230 V
12	Electrical shock protection	II
13	Electromagnetic compatibility (EMC)	No
14	Climate application	Clm App4
15	Ambient temperature	+5 to +35 C
16	Housing color	Black
17	Fire protection class	III
18	Flickering	<5%
19	Ingress protection (IP)	IP20
20	Mechanical shock protection	IK02/0,2 J
21	Energy efficiency class	A+
22	Inrush current	43 A
23	Inrush current impulse time	2.3 μs
24	Emergency power supply unit	No
25	Beam angle	D45
26	Warranty	60 months
27	Autonomy in emergency mode	-
28	Light flux in emergency mode	-