

QUO 07 GL D45 4000K (with driver)

Recessed LED-based luminaire

Description

Recessed LED downlight, made of aluminum, painted matt paint. Optical part protected by glass. Standard color: WH – white. Standard reflector – 45 degr.

Installation

Installed in ceilings.

Design

Aluminum housing, matte white painted aluminum decorative frame. The optical part is covered with a protective glass.

Optical part

Reflector.

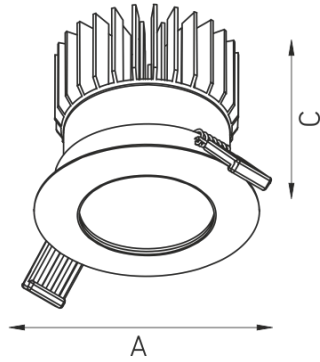
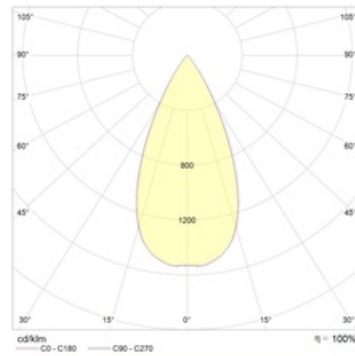

Dimensional characteristics

A	Diameter	65 mm
C	Height	56 mm
D	Diameter (mounting)	58 mm
	Weight	0.4 kg

Technical features

1	Article no.	1507000140
2	Light source	LED
3	Luminous flux	725 lm
4	Power compatibility	9 W
5	Energy efficiency	81 lm/W
6	Color rendering index (CRI)	>80
7	Color temperature	4000 K
8	Power factor (cosFI)	> 0,80
9	Alternating/direct current (AC/DC)	No
10	Dimming	-
11	Rated voltage	230 V
12	Electrical shock protection	II
13	Electromagnetic compatibility (EMC)	Yes
14	Climate application	Clim App4
15	Ambient temperature	0 to +40 C
16	Housing color	Golden
17	Fire protection class	III
18	Flickering	<5%
19	Ingress protection (IP)	IP20
20	Mechanical shock protection	IK02/0,2 J
21	Energy efficiency class	A+
22	Inrush current	43 A
23	Inrush current impulse time	2.3 µs
24	Emergency power supply unit	No
25	Beam angle	D45
26	Warranty	60 months
27	Autonomy in emergency mode	-
28	Light flux in emergency mode	-
29	Color of light	White