

DL POWER LED 40 D80 IP66 4000K mat /E/

Dust and moisture proof directional luminaires



Description

High-power dust- and moisture-proof directional luminaire. The IP66 rating allows using it not only for indoor sales areas and office/administrative facilities but also for petrol stations, entrances, industrial facilities etc.

Installation

Installed recessed in Armstrong type suspended ceilings, plasterboard ceilings, or Grilliato type ceilings (on a wire rope suspension).

Design

Die-cast aluminium housing. The driver in an IP-rated external box is located outside of the housing. External box weight with the driver: 1.7 kg.

Optical part

Transparent or satin glass diffuser. Reflector angles: 40, 60 or 80 degrees. LED type: COB.

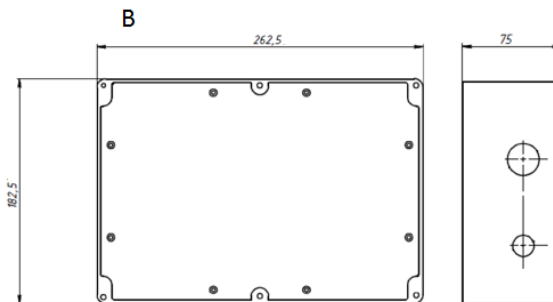
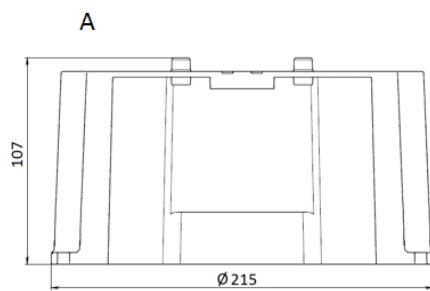
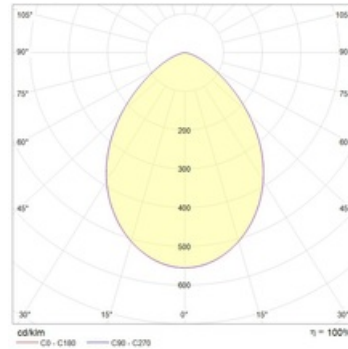

Dimensional characteristics

A	Diameter	232 mm
C	Height	161 mm
D	Diameter (mounting)	215 mm
	Weight	5.2 kg

Technical features

1	Article no.	1997015530
2	Light source	LED
3	Luminous flux	3400 lm
4	Power compatibility	36 W
5	Energy efficiency	94 lm/W
6	Color rendering index (CRI)	>85
7	Color temperature	4000 K
8	Power factor (cosFI)	> 0,94
9	Alternating/direct current (AC/DC)	Yes
10	Dimming	-
11	Rated voltage	230 V
12	Electrical shock protection	I
13	Electromagnetic compatibility (EMC)	Yes
14	Climate application	Clim App1
15	Ambient temperature	-25 to +40 C
16	Housing color	White
17	Fire protection class	II,IIa
18	Flickering	<1%
19	Ingress protection (IP)	IP66
20	Mechanical shock protection	IK02/0,2 J
21	Energy efficiency class	A+
22	Inrush current	20 A
23	Inrush current impulse time	0 µs
24	Emergency power supply unit	No
25	Beam angle	D80
26	Warranty	60 months
27	Autonomy in emergency mode	-
28	Light flux in emergency mode	-